

- Advanced L2 features
- Support for Multicast (IGMP Snooping, MVR)
- Advanced security functions (L2-L4 ACL, IP Source Guard, Dynamic ARP Inspection, etc.)
- Uninterruptible power supply from a rechargeable battery¹



MES1428



MES2428

The switches provide end users connection to networks of large enterprises, small and mid-sized businesses and service providers via Fast and Gigabit Ethernet interfaces.

The switches support Virtual Local Area Networks (VLAN), multicast groups and advanced security functions.

Uninterruptible power¹

MES1428B and MES2428B switches can be equipped with a rechargeable battery to ensure power supply in case of the primary network connection loss. The switch is also equipped with a power supply unit which allows the battery to be charged when AC power is available. Power supply redundancy makes it possible to monitor the state of the primary network and notify on a power type switching.

Technical features

	MES1428	MES1428B 	MES2428	MES2428B	MES2428T
General parameters					
Packet processor	Realtek RTL8332M	Realtek RTL8332M	Realtek RTL8382M	Realtek RTL8382M	Realtek RTL8382M
10/100BASE-TX	24	24	–	–	–
10/100/1000BASE-T (RJ-45)	–	–	24	24	24
Combo 10/100/1000BASE-T/ 100BASE-FX/1000BASE-X	4	4	4	4	4
Input dry contacts	–	–	–	–	4 pairs
Console port RS-232 (RJ-45)	1				
Bandwidth	12.8 Gbps	12.8 Gbps	56 Gbps	56 Gbps	56 Gbps
Throughput for 64-byte packets	9 MPPS	9 MPPS	41.658 MPPS	41.658 MPPS	41.658 MPPS
Buffer memory	512 KB				
RAM (DDR3)	256 MB				
ROM (SPI Flash)	32 MB				
MAC table	8K				
TCAM table	1.5K				
L2 Multicast groups (IGMP Snooping)	509				
VLAN table	4094				
Quality of Service (QoS)	8 output queues per port				
Link Aggregation Groups (LAG)	8 groups				
Jumbo frame size	the maximum packet size is 10 000 bytes				

¹Only for MES1428B and MES2428B

 – the device is under development

Technical features of redundant power supply* (for MES1428B and MES2428B)

	Battery capacity, Ah	Battery life, h	Battery charge time, h
MES1428B	12	≈17	≈9
	17	≈20	≈13
	20	≈22	≈15
MES2428B	12	≈9	≈9
	17	≈15	≈13
	20	≈17	≈15

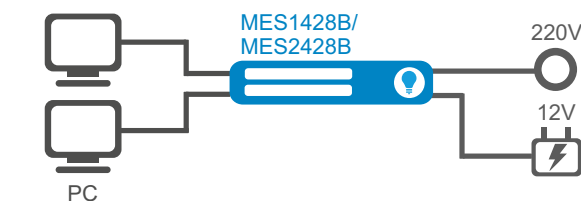

* Note:
– Specifications are given for environment temperature +25°C;
– It is recommended to use batteries with a capacity of at least 12 Ah for MES1428B and MES2428B.

Features and capabilities

Interface features

- Head-of-line blocking (HOL) protection
- Auto MDI/MDIX
- Jumbo frames
- Flow Control IEEE 802.3X
- Port mirroring
- RSPAN

MAC table

- Independent learning mode per VLAN
- MAC Multicast Support
- Configurable aging time of MAC addresses
- Static MAC Entries
- MAC change events monitoring per ports

VLAN features

- IEEE 802.1Q
- Q-in-Q
- Selective Q-in-Q (VLAN Translation)

L2 features

- STP (Spanning Tree Protocol, IEEE 802.1d)
- RSTP (Rapid Spanning Tree Protocol, IEEE 802.1d)
- MSTP (Multiple Spanning Tree Protocol, IEEE 802.1s)
- STP Root Guard
- STP Loop Guard
- STP BPDU Guard
- BPDU Filtering
- Spanning Tree Fast Link option
- Layer 2 Protocol Tunneling
- Loopback Detection (LBD)
- Port isolation
- Storm Control for different types of traffic (broadcast, multicast, unknown unicast)

L2 Multicast features

- Multicast profiles
- Static Multicast groups
- IGMP Snooping v1,2,3
- Port-based IGMP Snooping Fast Leave
- IGMP proxy-report features
- MLD Snooping v1,2
- IGMP Querier
- MVR

Link Aggregation functions

- Static LAG
- Dynamic LAG (LACP)
- LAG Balancing Algorithm

Service functions

- Virtual cable testing (VCT)
- Optical transceiver diagnostics

IPv6

- IPv6 Host
- Dual-stack

Security functions

- DHCP Snooping
- DHCP Option 82
- IP Source Guard
- Dynamic ARP Inspection (Protection)
- MAC-based authentication, Port Security, static MAC entries
- DoS attacks prevention
- Traffic segmentation
- DHCP clients filtering
- BPDU attacks prevention
- PPPoE Intermediate agent

💡 – MES1428B is under development

Features and capabilities

Access control lists (ACL)

- L2-L3-L4 ACL (Access Control List)
- IPv6 ACL
- ACL based on:
 - Switch port
 - IEEE 802.1p priority
 - VLAN ID
 - EtherType
 - DSCP
 - IP type
 - TCP/UDP port number
 - User Defined Bytes

Quality of service (QoS) and rate limiting

- Shaping, policing
- Support for IEEE 802.1p Class of Service
- Scheduling algorithms: Strict Priority/Weighted Round Robin (WRR)
- IEEE 802.1p priority for management VLAN
- ACL-based traffic classification
- ACL-based CoS/DSCP mark assignment
- CoS to DSCP remarking
- DSCP to CoS remarking
- ACL-based VLAN assignment

OAM

- IEEE 802.3ah, Ethernet OAM
- Dying Gasp
- IEEE 802.3ah Unidirectional Link Detection (UDLD)

Main management functions

- Download and upload of configuration file via TFTP/SFTP
- Automated backup of configuration file via TFTP/SFTP
- Simple Network Management Protocol (SNMP)
- Command Line Interface (CLI)
- Syslog
- Simple Network Time Protocol (SNTP)
- Traceroute
- LLDP (IEEE 802.1ab) + LLDP MED

- Access management – privilege levels for users
- Management interface blocking
- Local authentication
- IP addresses filtering for SNMP
- RADIUS and TACACS+ clients
- Telnet client
- Telnet server, SSH server
- Macro commands
- Input commands logging via TACACS+
- DHCP autoprovision
- DHCP Relay (support for IPv4)
- DHCP Relay Option 82
- PPPoE Circuit-ID tag adding
- Flash File System
- Debugging commands
- Limiting of traffic to CPU
- Password encryption
- Ping (support for IPv4/IPv6)
- IPv4/IPv6 static routes support
- Support for several versions of configuration files

Monitoring functions

- Interface statistics
- CPU utilization monitoring per task and per queue
- RAM utilization monitoring
- Temperature monitoring
- TCAM monitoring

Uninterruptible power supply¹

- Automatic switching to and from the rechargeable battery (12 V) in case of the primary (220 V) network fail
- Battery charging (12V) during primary network operation
- Power supply type monitoring (SNMP)
- Notifications of a power supply type switching
- Battery connection indication
- Low battery alarm
- Short circuit protection

Use case

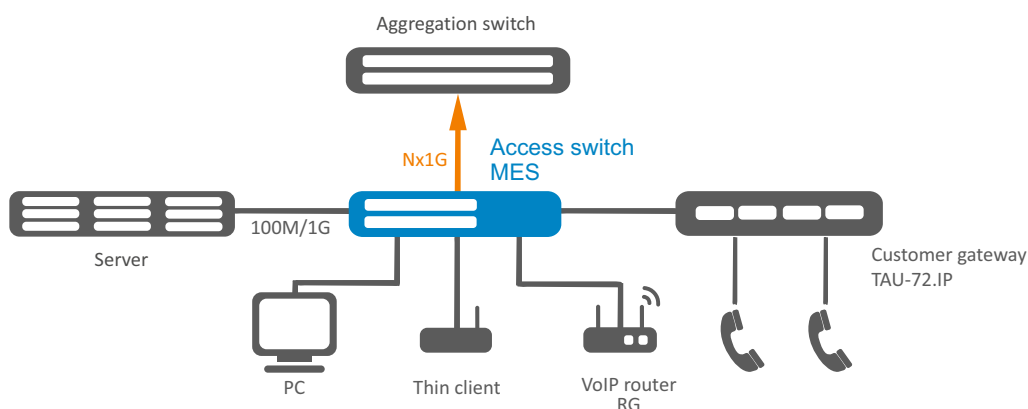

¹ Only for MES1428B and MES2428B

	MES1428	MES1428B 	MES2428	MES2428B	MES2428T
Physical specifications and environmental parameters					
Power supply	110–250 V AC, 60/50 Hz or 18–72 V DC	110–250 V AC, 60/50 Hz; 12 V DC	110–250 V AC, 60/50 Hz or 18–72 V DC	110–250 V AC, 60/50 Hz; 12 V DC	110–250 V AC, 60/50 Hz or 18–72 V DC
Input current	0.09–0.04 A	0.34–0.15 A, 1A	0.17–0.08 A	0.41–0.18 A, 1.8 A	0.17–0.08 A
Output current	no	1.7 A	no	1.7 A	no
Maximum power consumption	10 W	37 W (including battery charge)	18 W	45 W (including battery charge)	18 W
Hardware support for Dying Gasp	yes	no	yes	no	yes
Operating temperature	from -20 to +50 °C				
Storage temperature	from -40 to +70 °C				
Operating humidity	no more than 80%				
Cooling	passive				
Dimensions (WxHxD), mm	430x44x178				
Weight	2.26 kg		2.35 kg		2.37 kg

Ordering information

Name	Description
MES1428	Ethernet switch MES1428, 24 ports of 10/100BASE-TX, 4 Combo ports of 10/100/1000BASE-T/100BASE-FX/1000BASE-X, L2, 110–250 V AC, 18–72 V DC
MES1428B 	Ethernet switch MES1428B, 24 ports of 10/100BASE-TX, 4 Combo ports of 10/100/1000BASE-T/100BASE-FX/1000BASE-X, L2, 110–250 V AC, 12 V DC
MES2428 AC	Ethernet switch MES2428, 24 ports of 10/100/1000BASE-T, 4 Combo ports of 10/100/1000BASE-T/100BASE-FX/1000BASE-X, L2, 110–250 V AC
MES2428 DC	Ethernet switch MES2428, 24 ports of 10/100/1000BASE-T, 4 Combo ports of 10/100/1000BASE-T/100BASE-FX/1000BASE-X, L2, 18-72 V DC
MES2428B	Ethernet switch MES2428B, 24 ports of 10/100/1000BASE-T, 4 Combo ports of 10/100/1000BASE-T/100BASE-FX/1000BASE-X, L2, 110–250 V AC, 12 V DC
MES2428T AC	Ethernet switch MES2428T, 24 ports of 10/100/1000BASE-T, 4 Combo ports of 10/100/1000BASE-T/100BASE-FX/1000BASE-X, 4 input dry contact pairs, L2, 110–250 V AC
MES2428T DC	Ethernet switch MES2428T, 24 ports of 10/100/1000BASE-T, 4 Combo ports of 10/100/1000BASE-T/100BASE-FX/1000BASE-X, 4 input dry contact pairs, L2, 18–72 V DC

 – equipment is under development

Contact us

About ELTEX

+7 (383) 274 10 01
+7 (383) 274 48 48

eltex@eltex-co.ru

www.eltex-co.com

ELTEX company is a leading Russian developer and manufacturer of telecommunication equipment with 28 years of history. Integrity of solutions and seamless integration capability into Customer infrastructure is a priority area of company development.